

Metal Pen Collection

YUYAO SUCCESSFUL STATIONERY PRODUCTS CO.,LTD

Add: C Linshan Industrial Development Zone, Yuyao City,
Zhejiang Province, 315462, China

Tel:0086-574-62079888 62079777

FaxL0086-574-62039168

E-mail:henry@nb-success.com

Http://www.nb-success.com

SAKESI[®]

SUCCESS

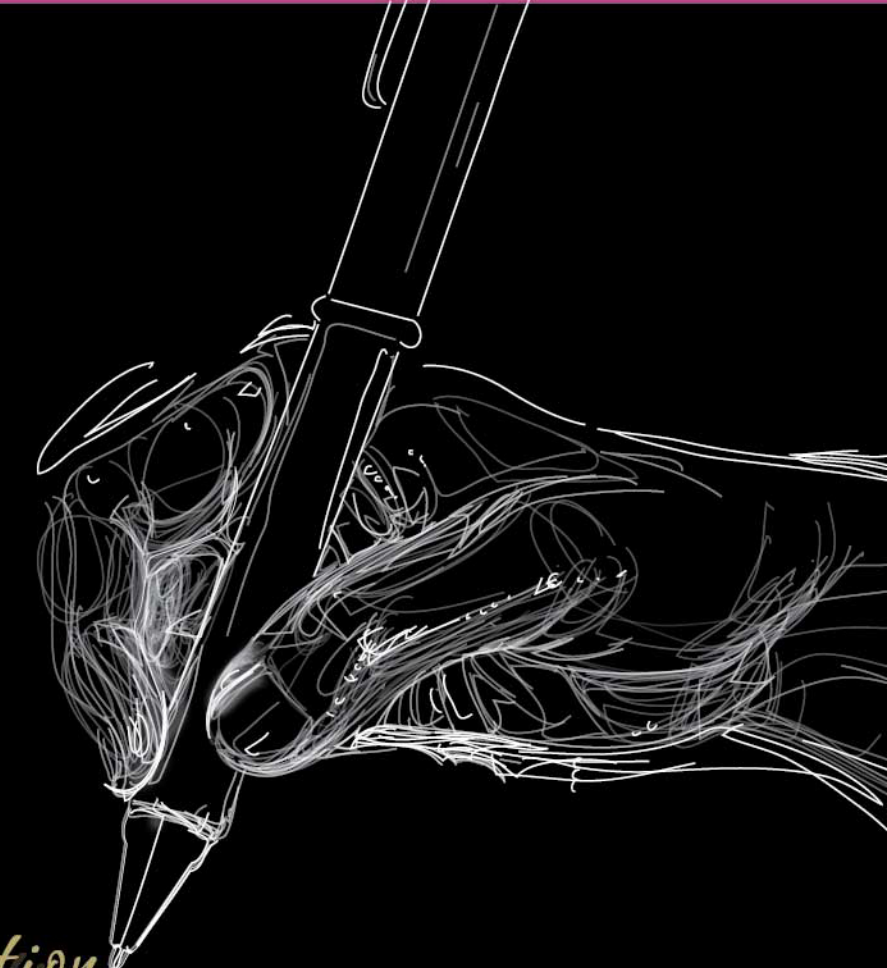

Metal Pen Collection

SUCCESS STATIONERY
CATALOGUE





*PAGE	01-08	High-End Pen	
*PAGE	09-23	Multi-Function Pen Series	
*PAGE	24-25	Rollerball Pen	
*PAGE	26-34	Twin Pen Set	
*PAGE	35-45	Twistable Parker Series	
*PAGE	46-52	Twistable Cross Series	
*PAGE	53-65	Retractable Parker Series	
*PAGE	66-68	Packing	

YUYAO SUCCESSFUL STATIONERY PRODUCTS CO.,LTD
Add: C Linshan Industrial Development Zone, Yuyao City,
Zhejiang Province, 315462, China
Tel:0086-574-62079888 62079777
FaxL0086-574-62039168
E-mail:henry@nb-success.com
Http://www.nb-success.com





www.nb-success.com

BRIEF INTRODUCTION

Yuyao Successful Stationery Products Co.,Ltd was established in year 2002. Our main products are High-end metal pen, Ball pen, Gel pen, Rollerpen, Highlighter, Permanent Marker, Dry erase marker and some other writing instruments. With 27000 square meters production facility and 450 employees, we are on the way to be a professional stationery manufacturer for Promotion and Retailing business. We also warmly welcome OEM opportunity.



Injection machines
For plastic parts or barrels



Automatic pipecavity machines
For barrel shaping



Automatic lathing workshop
For metal trims processing with high precision



Automatic painting lines
For different finishes processing such as glossy/rubberize/ translucent/pearl/marble/wooden finish



Dust-free Assembly Area
For final assembling



Dual-color injection machines
For two-color plastic parts injection



Automatic numeral control machines
For metal parts such as tip, plunger, dome, mid-connector, band



Inspection and testing lab
For testing on parts or pens such as refill writing length, salt atmosphere test, constant temperature drier-cold & hot temperature cycling test, water boiling test, pull-out force test, hardness test, drop test stand





Laser cutting
For permanent logo or artwork cutting on pen

High-End Pen

	HE001	01
	HE001-2	03
	HE002	05
	HE008	06
	RD087	07
	SKS889-1	07
	SKS1016-2	07
	SKS629-2	08
	SKS682-2	08
	SKS682-2R	08

Multi-Function Pen Series

	SKS736	09
	SKS738	09
	RD373	10
	RD277	10
	RD396	11
	SKS712	11
	SKS713	12
	SKS715	12
	SKS716	13
	SKS717	13
	SKS720	14

	SKS721	14
	SKS723	15
	SKS726-1	15
	SKS727-1	16
	SKS729	16
	SKS730	17
	SKS732	17
	SKS785	18
	SKS786	18
	SKS787	19
	SKS790-2	19
	SKS791	20
	SKS792	20
	SKS795	21
	SKS797-1	21
	SKS793-1	22
	SKS793-2	22
	SKS798	23
	SKS728	23

Rollerball Pen

	SKS1016	24
	SKS1017	24
	SKS1033	25
	SKS1037-1	25

Twin Pen Set

	SKS202	26
	SKS203	26
	SKS206	27
	SKS209	27
	SKS210	28
	SKS212	28
	SKS213	29
	SKS215	29
	SKS216	30
	SKS217	30
	SKS218	31
	SKS219	31
	SKS220	32

	SKS221	32
	SKS223	33
	SKS224	33
	SKS225	34
	SKS226	34

Twistable Parker Series

	SKS600-1	35
	SKS601-2	35
	SKS610	36
	SKS624	36
	SKS620	37
	SKS620-1	37
	SKS633	38
	SKS634	38
	SKS637	39
	SKS638	39
	SKS641	40
	SKS642-2	40
	SKS645	41
	SKS655	41
	SKS640	42

	SKS661-2	42
	SKS668	43
	SKS682	43
	SKS683	44
	SKS691	44
	SKS693	45
	RD345	45

Twistable Cross Series

	SKS601	46
	SKS604	46
	SKS605	47
	SKS627	47
	SKS608	48
	SKS608-1	48
	SKS667-2	49
	SKS629	49
	SKS649-2	50
	SKS666	50
	SKS673	51
	SKS673-1	51
	SKS685	52
	SKS692	52

Retractable Parker Series

	SKS896	53
	RD603	53
	SKS889-6	54

	RD605	54
	SKS803	55
	SKS803-1	55
	SKS803-2	55
	SKS803-6	56
	SKS804	56
	SKS806-1	57
	SKS812	57
	SKS827	58
	SKS835	58
	SKS819	59
	SKS823-1	59
	SKS820	60
	SKS821	60
	SKS822	60
	SKS828	61
	SKS832	61
	SKS835-8	62
	SKS838	62
	SKS840-1	63
	SKS841-2	63
	SKS860	64
	SKS868	64
	SKS881-1	65
	SKS893-1	65

Packing

SURFACE TREATMENT

Note: Surface treatment for each pen is optional. Special requirements for surface treatment are acceptable at a minimum order of 5000PCS each color.

Barrel finishes available:

- | | |
|--|-----------------------------------|
| 1.3D translucent lacquer | 15.Pearl nickel |
| 2.Satin lacquer | 16.Gunmetal |
| 3.Metallic lacquer | 17.Special plating |
| 4.Marble lacquer | 18.Transparent coating |
| 5.Wooden lacquer | 19.Oxidized |
| 6.Pearl silver | 20.Satin gold |
| 7.Satin lacquer with rubber finish | 21.Polished stainless steel |
| 8.Fluorescent lacquer with rubber finish | 22.Satin polished stainless steel |
| 9.3D translucent lacquer on nickel plating | 23.Leather lacquer |
| 10.Frosted | 24.Celluloid |
| 11.Satin silver | |
| 12.Satin chrome | 1-10:Lacquer spraying |
| 13.Shining chrome | 11-20:Electroplating |
| 14.Shining nickel | 21-22:Polishing |
| | 23-24:Special material |

Parts finish available:

- Satin chrome
- Satin silver
- Shining chrome
- Shining gold
- Shining nickel
- Shining silver
- Rose gold
- 1-7:Electroplating

Logo imprint:

- Silkscreen
- Pad printing
- Laser engraving
Brass color
Silver color
- Oxidized
- Special plating
Bi-color plating
Embossment
Etched
- Laser cutting



High-End Pen

Function: Twistable
Refill: Parker refill
Material: Brass
Packing: 1/50/200
Meas: 45x16x13cm
G.W.: 10Kg N.W.: 9Kg

HE001

Unit Weight(g): 46

Length(mm): 140

Diameter(mm): 13

Tip point: 0.8/1.0mm



High-End Pen

HE001-2

Unit Weight(g): 45

Length(mm): 130

Diameter(mm): 13

Tip point:0.8/1.0mm



Function: Twistable
Refill: Parker refill
Material: Brass
Packing: 1/50/500
Meas: 45x16x13cm
G.W.: 10Kg N.W.: 9Kg

High-End Pen



High-End Pen

HE002

Unit Weight(g): 33

Length(mm): 127

Diameter(mm): 13

Tip point:0.5/0.7mm



Refill: Rollerball refill
Material: Brass
Packing: 1/50/400
Meas: 45x30x12cm
G.W.: 13Kg N.W.: 12Kg



High-End Pen



Function: Twistable
Refill: Parker refill
Material: Brass
Packing: 1/50/500
Meas: 45x30x12cm
G.W.: 11Kg N.W.: 10Kg



HE008

Unit Weight(g): 45

Length(mm): 136

Diameter(mm): 13

Tip point:0.8/1.0mm

Logo size: 40x9mm

Laser Cutting



Function: Retractable
 Refill: Parker refill
 Material: Brass
 Packing: 1/50/500
 Meas: 45x30x11cm
 G.W.: 13Kg N.W.: 12Kg

RD087

Unit Weight(g): 24
 Length(mm): 140
 Diameter(mm): 10
 Tip point:0.8/1.0mm
 Logo size:50x8mm



SKS889-1

Unit Weight(g): 21
 Length(mm): 139
 Diameter(mm): 8.5
 Tip point:0.8/1.0mm
 Logo size:50x5.5mm



Function: Retractable
 Refill: Parker refill
 Material: Brass
 Packing: 1/50/500
 Meas: 45x30x10cm
 G.W.: 11.5Kg N.W.: 10.5Kg



SKS1016-2

Unit Weight(g): 28
 Length(mm): 137
 Diameter(mm): 10.8
 Tip point:0.8/1.0mm
 Logo size:37x8.5mm



ROLLERBALL PEN
 Refill: Poller ball refill
 Material: Brass
 Packing: 1/50/500
 Meas: 45x30x12cm
 G.W.: 15Kg N.W.: 14Kg



Laser Cutting



Function:Twistable
 Refill: Cross refill
 Material: Brass and plastic
 Packing: 1/50/500
 Meas: 45x30x13cm
 G.W.: 13Kg N.W.: 12Kg

SKS629-2

Unit Weight(g): 24
 Length(mm): 137
 Diameter(mm): 12
 Tip point:0.8/1.0mm
 Logo size:45x9mm

SKS682-2

Unit Weight(g): 28
 Length(mm): 134
 Diameter(mm): 12.5
 Tip point:0.8/1.0mm
 Logo size:40x9mm



Function:Twistable
 Refill: Parker refill
 Material: Brass
 Packing: 1/50/500
 Meas: 45x30x13cm
 G.W.: 15Kg N.W.: 14Kg



Function:Cap off
 Refill: Roller ball
 Material: Brass
 Packing: 1/50/500
 Meas: 45x30x13cm
 G.W.: 18Kg N.W.: 17Kg

SKS682-2R

Unit Weight(g): 21
 Length(mm): 139
 Diameter(mm): 12.5
 Tip point:0.8/1.0mm
 Logo size:40x9mm

Multi-Function Pen Series



Multi-Function Pen



Function: Twistable
Refill: D1 refill
Material: Brass
Packing: 1/50/500
Meas: 45x16x13cm
G.W.: 13Kg N.W.: 12Kg

SKS736

Unit Weight(g): 24

Length(mm): 140

Diameter(mm): 11.5

Tip point:0.8/1.0mm

Logo size: 35x7mm



3 IN 1 PEN (OVAL SHAPE)
Refill: D1 refill
Material: Aluminum
Packing: 1/50/500
Meas: 45x30x18cm
G.W.: 13Kg N.W.: 12Kg

SKS738

Unit Weight(g): 24

Length(mm): 140

Diameter(mm): 13

Tip point:0.8/1.0mm

Logo size: 30x11mm



Multi-Function Pen



Highlighter + Ball Pen
 Refill: D1 refill
 Material: Aluminum
 Packing: 1/50/500
 Meas: 45x30x12cm
 G.W.: 12Kg N.w.:11Kg

RD373

Unit Weight(g): 22
 Tip point:0.8/1.0

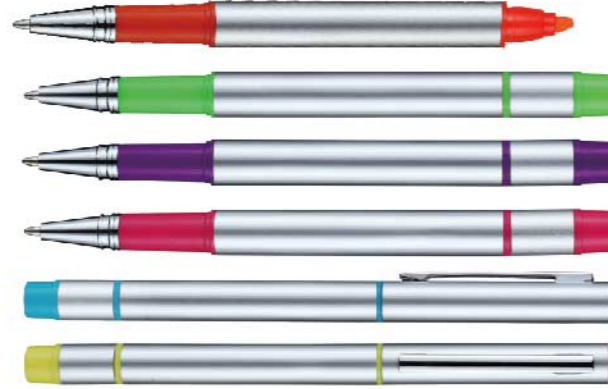

TOUCH TOP +Ball Pen
 Refill: Cross refill
 Material: Brass and silicon
 Packing: 1/50/500
 Meas: 45x30x13cm
 G.W.: 11.5kg N.W.:11.5kg

RD277

Unit Weight(g): 21
 Length(mm): 143
 Diameter(mm): 10.5
 Tip point:0.8/1.0mm
 Logo size:45x10mm



Multi-Function Pen



TOUCH TOP + Ball Pen
 Refill: D1 refill
 Material: Aluminum
 Packing: 1/50/500
 Meas: 45x30x12cm
 G.W.: 11Kg N.w.:10Kg

RD396

Unit Weight(g): 20
 Tip point:0.8/1.0



Stylus touch + Ball pen
 Refill: Parker refill
 Material: Aluminum
 Packing: 1/50/500
 Meas: 45x30x14cm
 G.W.: 10.5kg N.W.:9.5kg

SKS712

Unit Weight(g): 18.5
 Length(mm): 146
 Diameter(mm): 10.5
 Tip point:0.8/1.0mm
 Logo size:38x6.5mm

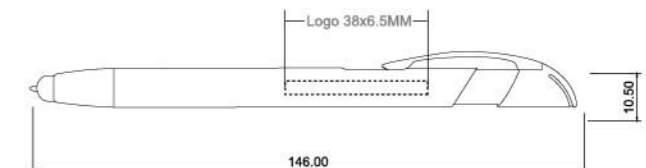

Multi-Function Pen



TOUCH TOP + Ball Pen
 Refill: Parker refill
 Material: Brass
 Packing: 1/50/500
 Meas: 45x30x12cm
 G.W.: 13Kg N.w.:12Kg

SKS713

Unit Weight(g): 24
 Tip point:0.8/1.0



SKS715

Unit Weight(g): 14
 Tip point:0.8/1.0



TOUCH TOP + Ball Pen
 Refill: D1 refill
 Material: Brass
 Packing: 1/50/500
 Meas: 40x26x12cm
 G.W.: 8Kg N.w.:7Kg

Multi-Function Pen



TOUCH TOP +Roller ball pen
 Refill: Roller ball refill
 Material: Aluminum
 Packing: 1/50/500
 Meas: 45x30x12cm
 G.W.: 16kg N.W.:15kg

SKS716

Unit Weight(g): 30
 Length(mm): 146
 Diameter(mm): 12
 Tip point:0.5/0.7mm
 Logo size:35x8mm



SKS717

Unit Weight(g): 22
 Tip point:0.8/1.0



TOUCH TOP + Ball Pen
 Refill: Parker refill
 Material: Aluminum and EVA
 Packing: 1/50/500
 Meas: 45x30x12cm
 G.W.: 12Kg N.w.:11Kg

Multi-Function Pen



TOUCH TOP + Ball Pen
 Refill: Parker refill
 Material: Aluminum and Rubberize
 Packing: 1/50/500
 Meas: 45x30x14cm
 G.W.: 12.5Kg N.w.:11.5Kg

SKS720

Unit Weight(g): 23
 Tip point:0.8/1.0



Multi-Function Pen



TOUCH TOP + Ball Pen
 Refill: D1 refill
 Material: Aluminum
 Packing: 1/50/500
 Meas: 45x30x12cm
 G.W.: 11Kg N.w.:10Kg

SKS723

Unit Weight(g): 20
 Tip point:0.8/1.0



SKS721

Unit Weight(g): 26
 Length(mm): 135
 Diameter(mm): 10
 Tip point: 0.5/0.7mm
 Logo size:35x8mm



TOUCH TOP +Roller ball pen
 Refill: Roller ball refill
 Material: Brass
 Packing: 1/50/500
 Meas: 45x30x12cm
 G.W.: 14kg N.W.:13kg



ROLLER BALL PEN
 Refill: Roller Ball Refill
 Material: Brass
 Packing: 1/50/500
 Meas: 45x30x12cm
 G.W.: 11Kg N.W.: 10Kg

SKS726-1

Unit Weight(g): 20
 Tip point:0.5/0.7



Multi-Function Pen



TOUCH TOP + Ball Pen
 Refill: 2 color D1 refill
 Material: Brass
 Packing: 1/50/500
 Meas: 45x30x12cm
 G.W.: 13Kg N.w.:12Kg

SKS727-1

Unit Weight(g): 24
 Tip point:0.8/1.0



SKS729

Unit Weight(g): 23
 Tip point:0.8/1.0



TOUCH TOP + Ball Pen
 Refill: Parker refill
 Material: Aluminum and Silicon
 Packing: 1/50/500
 Meas: 45x30x12cm
 G.W.: 12.5Kg N.W.: 11.5Kg

Multi-Function Pen



TOUCH TOP + Rope
 Material: Aluminum
 Packing: 1/100/1000
 Meas: 45x30x12cm
 G.W.: 11kg N.W.:10kg

SKS730

Unit Weight(g): 10
 Length(mm): 50
 Diameter(mm): 9
 Tip point:0.8/1.0mm
 Logo size:30x8mm



SKS732

Unit Weight(g): 22
 Tip point:0.8/1.0



3 in 1 Pen
 Refill: D1 refill
 Material: Aluminum and Rubberize
 Packing: 1/50/500
 Meas: 45x30x12cm
 G.W.: 12Kg N.w.:11Kg

Multi-Function Pen



TOUCH TOP + Ball Pen
Refill: Parker refill
Material: Aluminum
Packing: 1/50/500
Meas: 45x30x12cm
G.W.: 10Kg N.w.:9Kg

SKS785

Unit Weight(g): 18

Tip point:0.8/1.0



SKS786

Unit Weight(g): 23

Tip point:0.5/0.7



TOUCH TOP + Roller Ball Pen
Refill: Rollerball refill
Material: Aluminum
Packing: 1/50/500
Meas: 45x30x12cm
G.W.: 12.5Kg N.w.:11.5Kg

Multi-Function Pen



TOUCH TOP + Ball Pen
Refill: D1
Material: Brass and Plastic
Packing: 1/50/500
Meas: 45x30x14cm
G.W.: 13Kg N.W.: 12Kg

SKS787

Unit Weight(g): 24

Tip point:0.8/1.0



SKS790-2

Unit Weight(g): 18

Tip point:0.8/1.0



TOUCH TOP + Ball Pen
Refill: D1 refill
Material: Aluminum
Packing: 1/50/500
Meas: 45x30x12cm
G.W.: 10Kg N.w.:9Kg

Multi-Function Pen



TOUCH TOP + Ball Pen
Refill: Parker refill
Material: Brass
Packing: 1/50/500
Meas: 45x30x12cm
G.W.: 12Kg N.w.:11Kg

SKS791

Unit Weight(g): 22

Tip point:0.8/1.0



SKS792

Unit Weight(g): 16

Tip point:0.8/1.0



TOUCH TOP + Ball Pen
Refill: D1 refill
Material: Aluminum
Packing: 1/50/500
Meas: 45x30x12cm
G.W.: 9Kg N.W.: 8Kg

Multi-Function Pen



TOUCH TOP + Ball Pen
Refill: Parker refill
Material: Brass and Plastic
Packing: 1/50/500
Meas: 45x30x14cm
G.W.: 15Kg N.W.: 14Kg

SKS795

Unit Weight(g): 28

Tip point:0.8/1.0mm



SKS797-1

Unit Weight(g): 21

Tip point:0.5/0.7



TOUCH TOP +Roller ball Pen
Refill: Roller ball refill
Material: Aluminum
Packing: 1/100/1000
Meas: 45x30x13cm
G.W.: 11.5kg N.W.:11.5kg



Multi-Function Pen



TOUCH TOP + Ball Pen
Refill: Cross refill
Material: Aluminum
Packing: 1/100/1000
Meas: 45x30x13cm
G.W.: 13Kg N.W.: 10Kg

SKS793-1

Unit Weight(g): 12
Tip point:0.8/1.0mm



Multi-Function Pen



TOUCH TOP +Ball Pen
Refill: Cross refill
Material: Brass and plastic
Packing: 1/50/500
Meas: 45x30x12cm
G.W.: 11kg N.W.:10kg

SKS798

Unit Weight(g): 20
Tip point:0.8/1.0mm



SKS793-2

Unit Weight(g): 12
Tip point:0.8/1.0mm



TOUCH TOP +Ball Pen
Refill: Cross refill
Material: Aluminum
Packing: 1/50/500
Meas: 45x30x13cm
G.W.: 13kg N.W.:10kg



3 IN 1 PEN (LIGHT TIP PEN WITH STYLUS TOP)
Refill: D1
Material: Aluminum and Rubberize
Packing: 1/50/500
Meas: 45x30x12cm
G.W.: 11Kg N.w.:10Kg

SKS728

Unit Weight(g): 20
Tip point:0.8/1.0



Rollerball Pen



Refill: Rollerball refill
 Material: Plastic barrel
 Packing: 1/50/500
 Meas: 45x30x12cm
 G.W.: 9.5Kg N.W.: 8.5Kg

SKS1016

Unit Weight(g): 17

Tip point:0.8/1.0mm

Logo size:38x8mm



SKS1017

Unit Weight(g): 21

Length(mm): 137.7

Diameter(mm): 10.5

Tip point:0.8/1.0mm

Logo size:38x8mm



Refill: Roller ball refill
 Material: Brass
 Packing: 1/50/500
 Meas: 45x30x12cm
 G.W.: 11.5Kg N.W.: 10.5Kg

Rollerball Pen



Refill: Roller ball refill
 Material: Aluminum
 Packing: 1/50/500
 Meas: 45x30x12cm
 G.W.: 11.5Kg N.W.: 11.5Kg

SKS1033

Unit Weight(g): 21

Tip point:0.8/1.0mm



SKS1037-1

Unit Weight(g): 30

Tip point:0.8/1.0



Refill: Rollerball refill
 Material: Aluminum
 Packing: 1/50/500
 Meas: 45x30x12cm
 G.W.: 16Kg N.W.:15Kg

Twin Pen Set



SKS202

Ball point:0.8/1.0mm Roller Ball:0.5/0.7mm

Specification:

Weight:48g

ONE BALL POINT PEN &
ONE FREE INK ROLLER BALL PENL



SKS203

Ball point:0.8/1.0mm Pencil:0.5/0.7mm

Specification:

Weight:42g

ONE BALL POINT PEN &
ONE MECHANICAL PENCIL



Twin Pen Set



SKS206

Ball point:0.8/1.0mm Roller Ball:0.5/0.7mm

Specification:

Weight:45g

ONE BALL POINT PEN &
ONE FREE INK ROLLER BALL PENL



SKS209

Ball point:0.8/1.0mm Roller Ball:0.5/0.7mm

Specification:

Weight:76g

ONE BALL POINT PEN &
ONE FREE INK ROLLER BALL



Twin Pen Set



SKS210

Ball point:0.8/1.0mm Roller Ball:0.5/0.7mm

Specification:

Weight:86g

ONE BALL POINT PEN &
ONE FREE INK ROLLER BALL PENL

BLACK BLUE RED GREEN SILVER



SKS212

Ball point:0.8/1.0mm Roller Ball:0.5/0.7mm

Specification:

Weight:78g

ONE BALL POINT PEN &
ONE FREE INK ROLLER BALL PENL

BLACK BLUE RED GREEN SILVER

Twin Pen Set



SKS213

Ball point:0.8/1.0mm Roller Ball:0.5/0.7mm

Specification:

Weight:65g

ONE BALL POINT PEN &
ONE FREE INK ROLLER BALL

BLACK BLUE RED GREEN SILVER



SKS215

Ball point:0.8/1.0mm Roller Ball:0.5/0.7mm

Specification:

Weight:81g

ONE BALL POINT PEN &
ONE FREE INK ROLLER BALL PENL

BLACK BLUE RED GREEN SILVER

Twin Pen Set



SKS216

Ball point:0.8/1.0mm Roller Ball:0.5/0.7mm

Specification:

Weight:90g

ONE BALL POINT PEN &
ONE FREE INK ROLLER BALL



SKS217

Ball point:0.8/1.0mm Roller Ball:0.5/0.7mm

Specification:

Weight:78g

ONE BALL POINT PEN &
ONE FREE INK ROLLER BALL PENL



Twin Pen Set



SKS218

Ball point:0.8/1.0mm Roller Ball:0.5/0.7mm

Specification:

Weight:82g

ONE BALL POINT PEN &
ONE FREE INK ROLLER BALL



SKS219

Ball point:0.8/1.0mm Roller Ball:0.5/0.7mm

Specification:

Weight:58g

ONE BALL POINT PEN &
ONE FREE INK ROLLER BALL PENL



Twin Pen Set



SKS220

Ball point:0.8/1.0mm Roller Ball:0.5/0.7mm

Specification:

Weight:62g

ONE BALL POINT PEN &
ONE FREE INK ROLLER BALL PENL

BLACK BLUE RED GREEN SILVER



SKS221

Ball point:0.8/1.0mm Roller Ball:0.5/0.7mm

Specification:

Weight:68g

ONE BALL POINT PEN &
ONE FREE INK ROLLER BALL PENL

BLACK BLUE RED GREEN SILVER

Twin Pen Set



SKS223

Ball point:0.8/1.0mm Roller Ball:0.5/0.7mm

Specification:

Weight:46g

ONE BALL POINT PEN &
ONE FREE INK ROLLER BALL PENL

BLACK BLUE RED GREEN SILVER



SKS224

Ball point:0.8/1.0mm Roller Ball:0.5/0.7mm

Specification:

Weight:60g

ONE BALL POINT PEN &
ONE FREE INK ROLLER BALL PENL

BLACK BLUE RED GREEN SILVER

Twin Pen Set



SKS225

Ball point:0.8/1.0mm Roller Ball:0.5/0.7mm

Specification:

Weight:48g

ONE BALL POINT PEN &
ONE FREE INK ROLLER BALL PENL

BLACK BLUE RED GREEN SILVER



SKS226

Ball point:0.8/1.0mm Roller Ball:0.5/0.7mm

Specification:

Weight:46g

ONE BALL POINT PEN &
ONE FREE INK ROLLER BALL PENL

BLACK BLUE RED GREEN SILVER

Twistable Parker Series



Twistable Parker Series

SKS600-1

Unit Weight(g): 19

Length(mm): 118.6

Diameter(mm): 10.8

Tip point:0.8/1.0mm

Logo size:42x7.5mm



Mini Pen
Function: Twistable
Refill: Parker refill
Material: Aluminum
Packing: 1/50/500
Meas: 45x28x10cm
G.W.: 10.5Kg N.W.: 9.5Kg

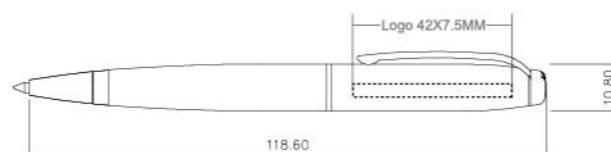

SKS601-2

Unit Weight(g): 22

Length(mm): 119.3

Diameter(mm): 11.5

Tip point:0.8/1.0mm

Logo size:42x7.5mm



Mini Pen
Function: Twistable
Refill: Parker refill
Material: Brass
Packing: 1/50/500
Meas: 45x28x10cm
G.W.: 12Kg N.W.: 11Kg



Twistable Parker Series

SKS610

Unit Weight(g): 27

Tip point:0.8/1.0mm

Logo size:60x8mm



Function: Twistable
Refill: Parker refill
Material: Brass and Acrylic
Packing: 1/50/500
Meas: 45x30x12cm
G.W.: 16.5Kg N.W.: 15.5Kg

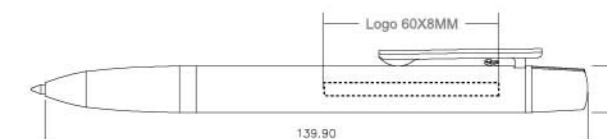

SKS624

Unit Weight(g): 21

Length(mm): 142

Diameter(mm): 12

Tip point:0.8/1.0mm

Logo size:37x6.5mm



Function: Twistable
Refill: Parker refill
Material: Brass
Packing: 1/50/500
Meas: 45x30x13cm
G.W.: 11.5Kg N.W.: 10.5Kg

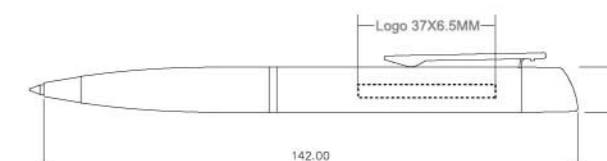

Twistable Parker Series



Function: Twistable
 Refill: Parker refill
 Material: Brass
 Packing: 1/50/500
 Meas: 45x30x13cm
 G.W.: 15Kg N.W.: 14Kg

SKS620

Unit Weight(g): 28

Length(mm): 137

Diameter(mm): 12.2

Tip point: 0.8/1.0mm

Logo size: 40x8mm

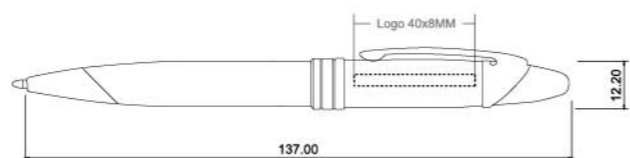

SKS620-1

Unit Weight(g): 24

Length(mm): 140.5

Diameter(mm): 12.4

Tip point: 0.8/1.0mm

Logo size: 40x8mm

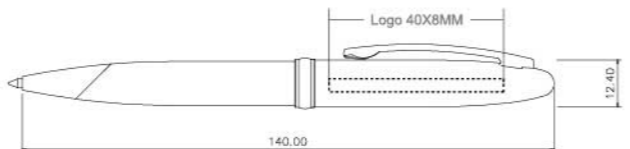

Function: Twistable
 Refill: Parker refill
 Material: Brass
 Packing: 1/50/500
 Meas: 45x30x13cm
 G.W.: 13Kg N.W.: 12Kg

Twistable Parker Series



Function: Twistable
 Refill: Parker refill
 Material: Aluminum
 Packing: 1/100/1000
 Meas: 45x30x13cm
 G.W.: 12.5Kg N.W.: 11.5Kg

SKS633

Unit Weight(g): 23

Length(mm): 138

Diameter(mm): 12

Tip point: 0.8/1.0mm

Logo size: 35x6.5mm

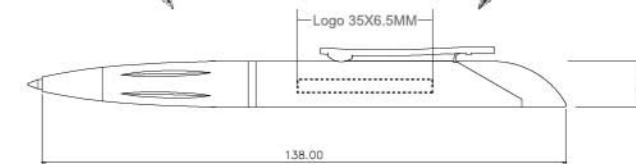

SKS634

Unit Weight(g): 32

Length(mm): 139

Diameter(mm): 11.5

Tip point: 0.8/1.0mm

Logo size: 30x6.5mm

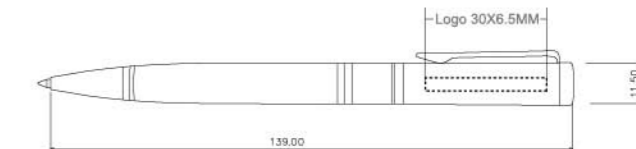

Function: Twistable
 Refill: Parker refill
 Material: Brass
 Packing: 1/50/500
 Meas: 45x30x13cm
 G.W.: 17Kg N.W.: 16Kg

Twistable Parker Series

SKS637

Unit Weight(g): 34

Length(mm): 135

Diameter(mm): 11.5

Tip point:0.8/1.0mm

Logo size:30x7mm



Function: Twistable
 Refill: Parker refill
 Material: Brass
 Packing: 1/50/500
 Meas: 45x30x13cm
 G.W.: 13Kg N.W.: 12Kg

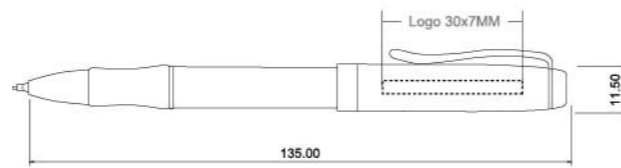

SKS638

Unit Weight(g): 20.5

Length(mm): 113

Diameter(mm): 12.6

Tip point:0.8/1.0mm

Logo size:53x7.5mm



Function: Twistable
 Refill: Parker refill
 Material: Brass
 Packing: 1/50/500
 Meas: 45x30x15cm
 G.W.: 11Kg N.W.: 10Kg



Twistable Parker Series

SKS641

Unit Weight(g): 40

Length(mm): 136.6

Diameter(mm): 12.3

Tip point:0.8/1.0mm

Logo size:30x8mm



Function: Twistable
 Refill: Parker refill
 Material: Brass
 Packing: 1/50/500
 Meas: 45x30x16cm
 G.W.: 21Kg N.W.: 20Kg



SKS642-2

Unit Weight(g): 27

Length(mm): 136.5

Diameter(mm): 11.2

Tip point:0.8/1.0mm

Logo size:30x6.5mm



Function: Twistable
 Refill: Parker refill
 Material: Aluminum
 Packing: 1/50/500
 Meas: 45x30x13cm
 G.W.: 14.5Kg N.W.: 13.5Kg



Twistable Parker Series



Function: Twistable
 Refill: Parker refill
 Material: Brass
 Packing: 1/50/500
 Meas: 45x30x13cm
 G.W.: 14.5Kg N.W.: 13.5Kg

SKS645

Unit Weight(g): 27

Length(mm): 140.6

Diameter(mm): 11

Tip point:0.8/1.0mm

Logo size:30x6.5mm



Function: Twistable
 Refill: Parker refill
 Material: Brass
 Packing: 1/50/500
 Meas: 45x30x13cm
 G.W.: 13.5Kg N.W.: 12.5Kg

SKS655

Unit Weight(g): 25

Length(mm): 137.4

Diameter(mm): 12

Tip point:0.8/1.0mm

Logo size:30x6.5mm

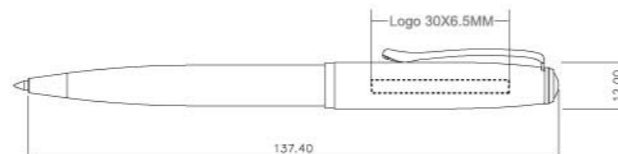

Twistable Parker Series



Function: Twistable
 Refill: Parker refill
 Material: Brass
 Packing: 1/50/500
 Meas: 45x30x14cm
 G.W.: 11Kg N.W.: 10Kg

SKS640

Unit Weight(g): 22

Tip point:0.8/1.0



Function: Twistable
 Refill: Parker refill
 Material: Brass and carbon fiber
 Packing: 1/50/500
 Meas: 45x30x13cm
 G.W.: 17.5Kg N.W.: 16.5Kg

SKS661-2

Unit Weight(g): 33

Length(mm): 140

Diameter(mm): 13

Tip point:0.8/1.0mm

Logo size:40x10mm

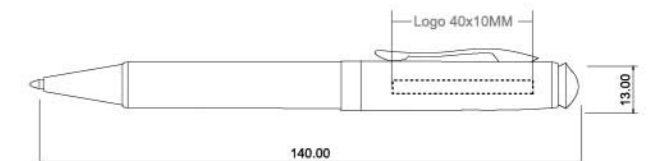

Twistable Parker Series



Function: Twistable
 Refill: Parker refill
 Material: Aluminum
 Packing: 1/50/500
 Meas: 45x30x10cm
 G.W.: 11Kg N.W.: 10Kg

SKS668

Unit Weight(g): 20

Length(mm): 136.9

Diameter(mm): 10

Tip point:0.8/1.0mm

Logo size:37x6.5mm



SKS682

Unit Weight(g): 30

Length(mm): 134

Diameter(mm): 12.5

Tip point:0.8/1.0mm

Logo size:40x10mm



Function: Twistable
 Refill: Parker refill
 Material: Brass
 Packing: 1/50/500
 Meas: 45x30x13cm
 G.W.: 16Kg N.W.: 15Kg

Twistable Parker Series



Function: Twistable
 Refill: Parker refill
 Material: Brass
 Packing: 1/50/500
 Meas: 45x30x13cm
 G.W.: 13Kg N.W.: 12Kg

SKS683

Unit Weight(g): 24

Length(mm): 134.1

Diameter(mm): 11.7

Tip point:0.8/1.0mm

Logo size:40x8mm



SKS691

Unit Weight(g): 20

Tip point:0.8/1.0

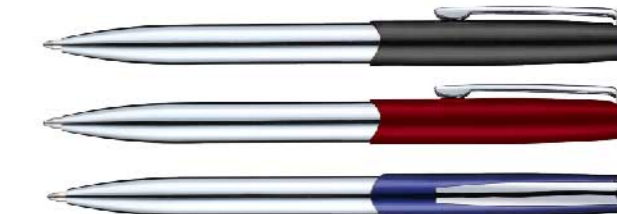

Function: Twistable
 Refill: Parker refill
 Material: Brass and Stainless Steel
 Packing: 1/50/500
 Meas: 45x30x12cm
 G.W.: 11Kg N.W.: 10Kg

Twistable Parker Series



Function: Twistable
Refill: Parker refill
Material: Brass
Packing: 1/50/500
Meas: 45x30x14cm
G.W.: 12Kg N.w.:11Kg

SKS693

Unit Weight(g): 22

Tip point:0.8/1.0



RD345

Unit Weight(g): 24

Tip point:0.8/1.0



Function: Twistable
Refill: Parker refill
Material: Brass
Packing: 1/50/500
Meas: 45x30x16cm
G.W.: 13Kg N.w.:12Kg

Twistable Cross Series

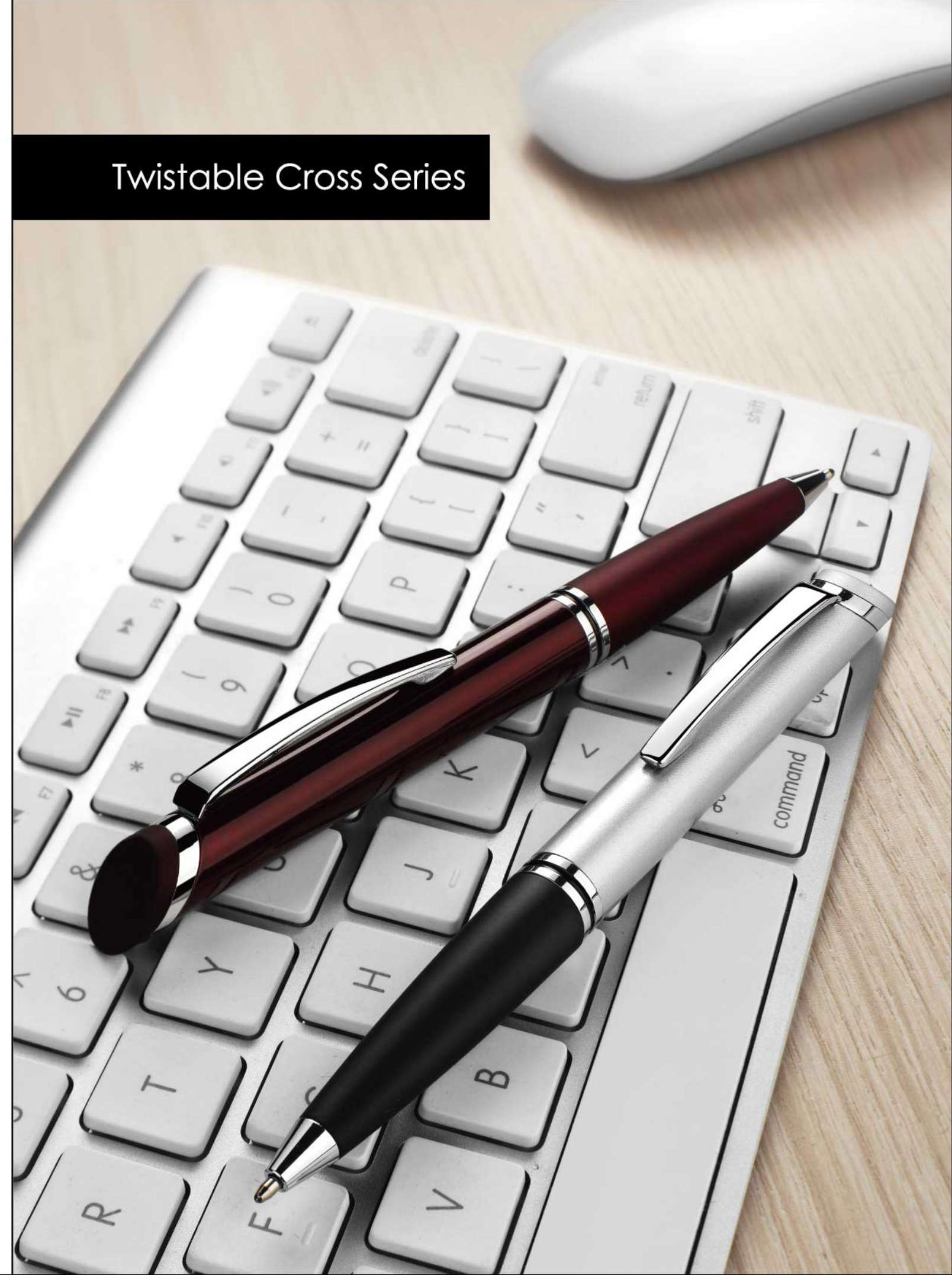

Twistable Cross Series



Function: Twistable
 Refill: Cross refill
 Material: Brass
 Packing: 1/50/500
 Meas: 45x30x12cm
 G.W.: 11.5Kg N.W.: 10.5Kg

SKS601

Unit Weight(g): 21
 Length(mm): 134
 Diameter(mm): 11
 Tip point:0.8/1.0mm
 Logo size:30x7.5mm



Twistable Cross Series



Function: Twistable
 Refill: Cross refill
 Material: Brass
 Packing: 1/50/500
 Meas: 45x30x12cm
 G.W.: 13.5Kg N.W.: 12.5Kg

SKS605

Unit Weight(g): 25
 Length(mm): 136
 Diameter(mm): 11.5
 Tip point:0.8/1.0mm
 Logo size:30x7.5mm

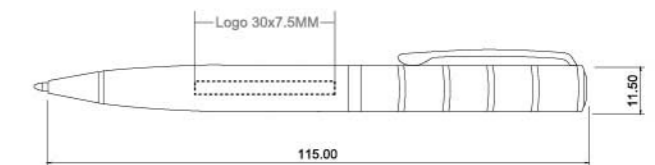

SKS604

Unit Weight(g): 23.5
 Length(mm): 137.5
 Diameter(mm): 11
 Tip point:0.8/1.0mm
 Logo size:40x5.5mm

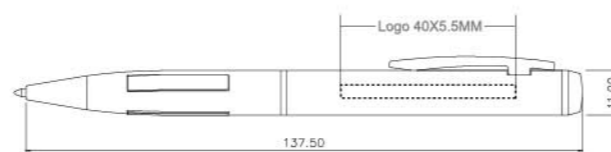

Function: Twistable
 Refill: Cross refill
 Material: Brass and Stainless Steel
 Packing: 1/50/500
 Meas: 45x30x12cm
 G.W.:11.5Kg N.W.:10.5Kg

SKS627

Unit Weight(g): 21
 Length(mm): 135.3
 Diameter(mm): 13
 Tip point:0.8/1.0mm
 Logo size:30x6.5mm

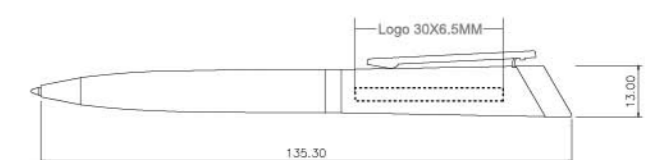

Twistable Cross Series



Function: Twistable
 Refill: Cross refill
 Material: Brass
 Packing: 1/50/500
 Meas: 45x30x16cm
 G.W.: 18Kg N.W.: 17Kg

SKS608

Unit Weight(g): 35

Length(mm): 135.2

Diameter(mm): 12.6

Tip point: 0.8/1.0mm

Logo size: 30x7.5mm

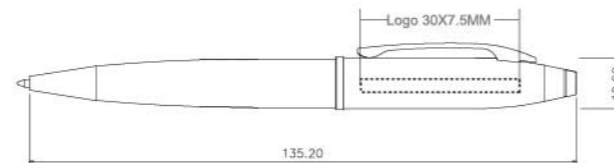

SKS608-1

Unit Weight(g): 24

Length(mm): 135.2

Diameter(mm): 12.6

Tip point: 0.8/1.0mm

Logo size: 30x7.5mm

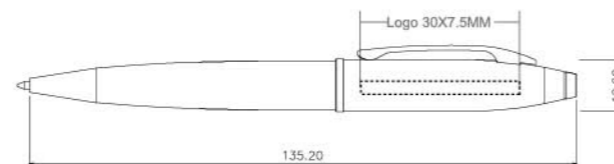

Function: Twistable
 Refill: Cross refill
 Material: Brass
 Packing: 1/50/500
 Meas: 45x30x16cm
 G.W.: 12.5Kg N.W.: 11.5Kg

Twistable Cross Series



Function: Twistable
 Refill: Cross refill
 Material: Aluminum and Plastic
 Packing: 1/50/500
 Meas: 45x30x12cm
 G.W.: 11Kg N.W.: 10Kg

SKS667-2

Unit Weight(g): 20

Length(mm): 135.9

Diameter(mm): 12

Tip point: 0.8/1.0mm

Logo size: 60x9mm

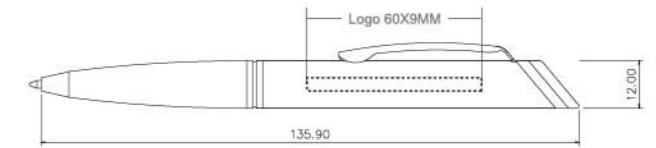

SKS629

Unit Weight(g): 24

Length(mm): 137.9

Diameter(mm): 11.5

Tip point: 0.8/1.0mm

Logo size: 60x8.5mm

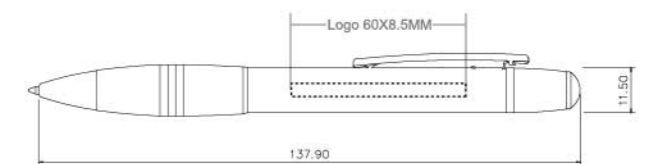

Function: Twistable
 Refill: Cross refill
 Material: Brass and Plastic
 Packing: 1/50/500
 Meas: 45x30x12cm
 G.W.: 13Kg N.W.: 12Kg

Twistable Cross Series



Function: Twistable
 Refill: Cross refill
 Material: Brass and aluminum
 Packing: 1/50/500
 Meas: 45x30x12cm
 G.W.: 12Kg N.W.: 11Kg

SKS649-2

Unit Weight(g): 22
 Length(mm): 136
 Diameter(mm): 11
 Tip point:0.8/1.0mm
 Logo size:60x8.5mm

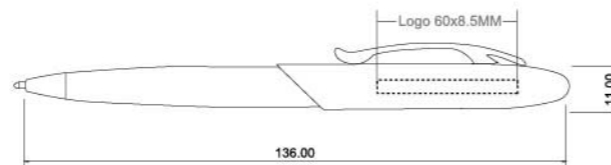

Twistable Cross Series



Function: Twistable
 Refill: Cross refill
 Material: Brass and Plastic
 Packing: 1/50/500
 Meas: 45x30x12cm
 G.W.: 11Kg N.W.: 9Kg

SKS673

Unit Weight(g):18
 Length(mm):136.9
 Diameter(mm): 12.5
 Tip point:0.8/1.0mm
 Logo size:35x8mm

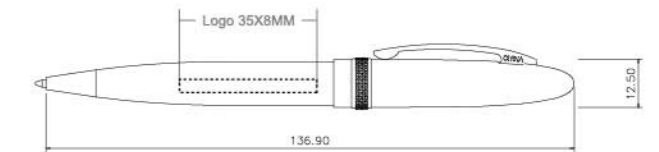

SKS666

Unit Weight(g): 18
 Length(mm): 110
 Diameter(mm): 10
 Tip point:0.8/1.0mm
 Logo size:50x8.5mm



Mini Pen
 Function: Twistable
 Refill: D1 refill
 Material: Brass
 Packing: 1/50/500
 Meas: 45x30x10cm
 G.W.: 10Kg N.W.: 9Kg

SKS673-1

Unit Weight(g): 18
 Length(mm): 134
 Diameter(mm): 12.4
 Tip point:0.8/1.0mm
 Logo size:27x8mm

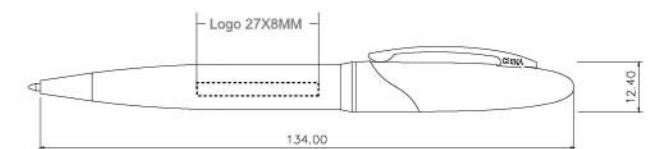

Function: Twistable
 Refill: Cross refill
 Material: Brass and Plastic
 Packing: 1/50/500
 Meas: 45x30x12cm
 G.W.: 10Kg N.W.: 19Kg

Twistable Cross Series



Function: Twistable
 Refill: Cross refill
 Material: Brass
 Packing: 1/50/500
 Meas: 45x30x12cm
 G.W.: 12Kg N.W.: 11Kg

SKS685

Unit Weight(g): 22
 Length(mm): 134
 Diameter(mm): 10
 Tip point: 0.8/1.0mm
 Logo size: 45x7mm

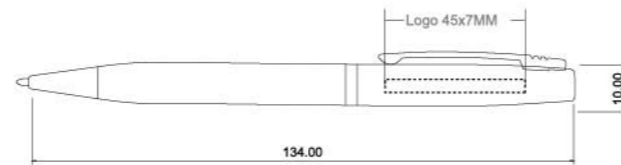

SKS692

Unit Weight(g): 23
 Length(mm): 134.2
 Diameter(mm): 13
 Tip point: 0.8/1.0mm
 Logo size: 45x8mm

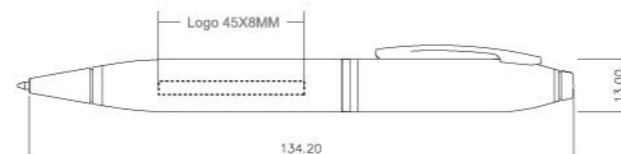

Function: Twistable
 Refill: Cross refill
 Material: Brass
 Packing: 1/50/500
 Meas: 45x30x12cm
 G.W.: 12.5Kg N.W.: 11.5Kg

Retractable Parker Series



Retractable Parker Series



Function: Retractable
 Refill: Parker refill
 Material: Brass
 Packing: 1/50/500
 Meas: 45x30x12cm
 G.W.: 10.5Kg N.W.: 9.5Kg

SKS896

Unit Weight(g): 26

Length(mm): 140

Diameter(mm): 10.5

Tip point:0.8/1.0mm

Logo size: 35x7mm



Function: Retractable
 Refill: Parker refill
 Material: Aluminum
 Packing: 1/50/500
 Meas: 45x30x12cm
 G.W.: 12.5Kg N.W.: 11.5Kg

RD603

Unit Weight(g): 23.5

Length(mm): 142

Diameter(mm): 10.5

Tip point:0.8/1.0mm

Logo size: 40x6.5mm



Retractable Parker Series

SKS889-6

Unit Weight(g): 21

Length(mm): 139

Diameter(mm): 8.5

Tip point:0.8/1.0mm

Logo size:50x5.5mm



Function: Retractable
 Refill: Parker refill
 Material: Brass
 Packing: 1/50/500
 Meas: 45x30x10cm
 G.W.: 11.5Kg N.W.: 10.5Kg



Function: Retractable
 Refill: Parker refill
 Material: Aluminum
 Packing: 1/50/500
 Meas: 45x30x16cm
 G.W.: 12.5Kg N.W.: 11.5Kg

RD605

Unit Weight(g): 23

Length(mm): 138

Diameter(mm): 11.5

Tip point:0.8/1.0mm

Logo size: 40x7mm



Retractable Parker Series



Function: Retractable
 Refill: Parker refill
 Material: Aluminum
 Packing: 1/50/500
 Meas: 45x30x13cm
 G.W.: 13Kg N.W.: 12Kg



SKS803

Unit Weight(g): 24
 Length(mm): 145.2
 Diameter(mm): 12
 Tip point:0.8/1.0mm
 Logo size:40x7mm

SKS803-1

Unit Weight(g): 24
 Length(mm): 145.2
 Diameter(mm): 12
 Tip point:0.8/1.0mm
 Logo size:40x7mm



Function: Retractable
 Refill: Parker refill
 Material: Aluminum
 Packing: 1/50/500
 Meas: 45x30x13cm
 G.W.: 13Kg N.W.: 12Kg



SKS803-2

Unit Weight(g): 24
 Length(mm): 144.4
 Diameter(mm): 12
 Tip point:0.8/1.0mm
 Logo size:40x7mm



Function: Twistable
 Refill: Parker refill
 Material: Aluminum
 Packing: 1/50/500
 Meas: 45x30x13cm
 G.W.: 13Kg N.W.: 12Kg



Retractable Parker Series



Function: Retractable
 Refill: Parker refill
 Material: Aluminum
 Packing: 1/50/500
 Meas: 45x30x14cm
 G.W.: 11.5Kg N.W.: 10.5Kg

SKS803-6

Unit Weight(g): 21
 Length(mm): 140
 Diameter(mm): 11.2
 Tip point:0.8/1.0mm
 Logo size:45x10mm



SKS804

Unit Weight(g): 20
 Length(mm): 130
 Diameter(mm): 11
 Tip point:0.8/1.0mm
 Logo size:40x6mm



Function: Retractable
 Refill: Parker refill
 Material: Brass
 Packing: 1/50/500
 Meas: 45x30x13cm
 G.W.: 11Kg N.W.: 10Kg



Retractable Parker Series



Function: Retractable
 Refill: Parker refill
 Material: Brass or Aluminum
 Packing: 1/50/500
 Meas: 45x30x12cm
 G.W.: 11Kg N.W.: 10Kg

SKS806-1

Unit Weight(g): 20
 Length(mm): 127.5
 Diameter(mm): 9
 Tip point:0.8/1.0mm
 Logo size:40x5mm

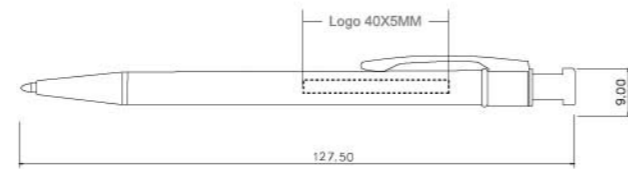

Retractable Parker Series



Function:Retractable
 Refill: Parker refill
 Material: Aluminum
 Packing: 1/50/500
 Meas: 45x30x12cm
 G.W.: 11Kg N.W.: 10Kg

SKS827

Unit Weight(g): 20
 Length(mm): 140
 Diameter(mm): 10
 Tip point:0.8/1.0mm
 Logo size:50x8mm



SKS812

Unit Weight(g): 18
 Length(mm): 136.5
 Diameter(mm): 11
 Tip point:0.8/1.0mm
 Logo size:40x8mm

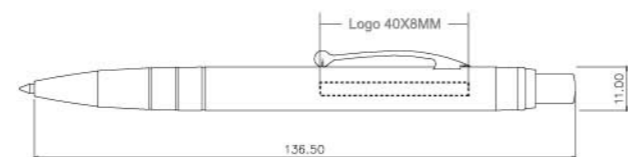

Function: Retractable
 Refill: Parker refill
 Material: Aluminum
 Packing: 1/50/500
 Meas: 45x30x13cm
 G.W.: 10Kg N.W.: 9Kg



Function: Retractable
 Refill: Parker refill
 Material: Brass and Plastic
 Packing: 1/50/500
 Meas: 45x30x12cm
 G.W.: 11Kg N.W.: 10Kg

SKS835

Unit Weight(g): 20
 Length(mm): 137.8
 Diameter(mm): 12
 Tip point:0.8/1.0mm
 Logo size:40x7.5mm

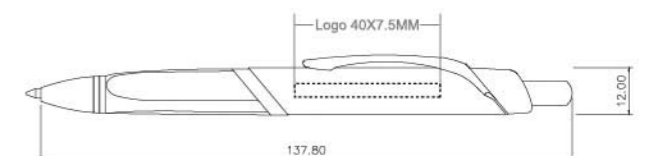

Retractable Parker Series



Function: Retractable
 Refill: Parker refill
 Material: Aluminum
 Packing: 1/50/500
 Meas: 45x30x12cm
 G.W.: 11.5Kg N.W.: 10.5Kg

SKS819

Unit Weight(g): 21
 Length(mm): 140.3
 Diameter(mm): 10
 Tip point:0.8/1.0mm
 Logo size:40x6mm

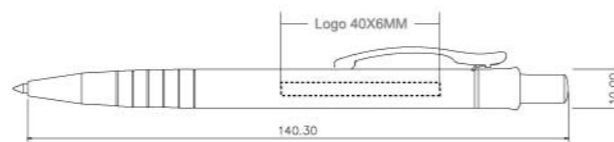

SKS823-1

Unit Weight(g): 20
 Tip point:0.8/1.0mm
 Logo size:38x6.5mm

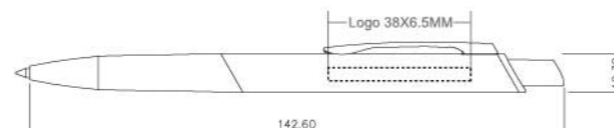

Function: Retractable
 Refill: Parker refill
 Material: Aluminum and Plastic
 Packing: 1/50/500
 Meas: 45x30x12cm
 G.W.: 11Kg N.W.: 10Kg

Retractable Parker Series



Function: Retractable
 Refill: Parker refill
 Material: Aluminum
 Packing: 1/50/500
 Meas: 45x30x10cm
 G.W.: 9Kg N.W.: 8Kg



SKS821

Unit Weight(g): 16
 Length(mm): 132
 Diameter(mm): 9.8
 Tip point:0.8/1.0mm
 Logo size:38x6.5mm



Function: Retractable
 Refill: Parker refill
 Material: Aluminum
 Packing: 1/50/500
 Meas: 45x30x10cm
 G.W.: 9Kg N.W.: 8Kg



SKS820

Unit Weight(g): 16
 Length(mm): 131.7
 Diameter(mm): 9.8
 Tip point:0.8/1.0mm
 Logo size:38x6.5mm

Function: Retractable
 Refill: Parker refill
 Material: Aluminum
 Packing: 1/50/500
 Meas: 45x30x10cm
 G.W.: 9Kg N.W.: 8Kg



SKS822

Unit Weight(g): 16
 Length(mm): 132
 Diameter(mm): 9.8
 Tip point:0.8/1.0mm
 Logo size:38x6.5mm



Retractable Parker Series



Function: Retractable
 Refill: Parker refill
 Material: Brass and Plastic
 Packing: 1/50/500
 Meas: 45x30x12cm
 G.W.: 10Kg N.W.: 9Kg

SKS828

Unit Weight(g): 18
 Length(mm): 140.4
 Diameter(mm): 11.1
 Tip point:0.8/1.0mm
 Logo size:38x6.5mm



SKS832

Unit Weight(g): 21
 Length(mm): 140
 Diameter(mm): 11.5
 Tip point:0.8/1.0mm
 Logo size: 30x6.5mm



Function: Retractable
 Refill: Parker refill
 Material: Brass
 Packing: 1/50/500
 Meas: 45x30x12cm
 G.W.: 11.5Kg N.W.: 10.5Kg

Retractable Parker Series



Function: Retractable
 Refill: Parker refill
 Material: Brass and plastic
 Packing: 1/50/500
 Meas: 45x30x12cm
 G.W.: 12Kg N.W.: 10Kg

SKS835-8

Unit Weight(g): 22
 Length(mm): 142
 Diameter(mm): 12
 Tip point:0.8/1.0mm
 Logo size:50x7.5mm



SKS838

Unit Weight(g): 24
 Tip point:0.8/1.0



Function: Retractable
 Refill: Parker refill
 Material: Brass and rubberize
 Packing: 1/50/500
 Meas: 45x30x16cm
 G.W.: 13Kg N.W.:12Kg

Retractable Parker Series



Function: Retractable
 Refill: Parker refill
 Material: Aluminum and Plastic
 Packing: 1/50/500
 Meas: 45x30x12cm
 G.W.: 13Kg N.W.: 12Kg

SKS840-1

Unit Weight(g): 24
 Length(mm): 141
 Diameter(mm): 11.5
 Tip point:0.8/1.0mm
 Logo size:45x9mm

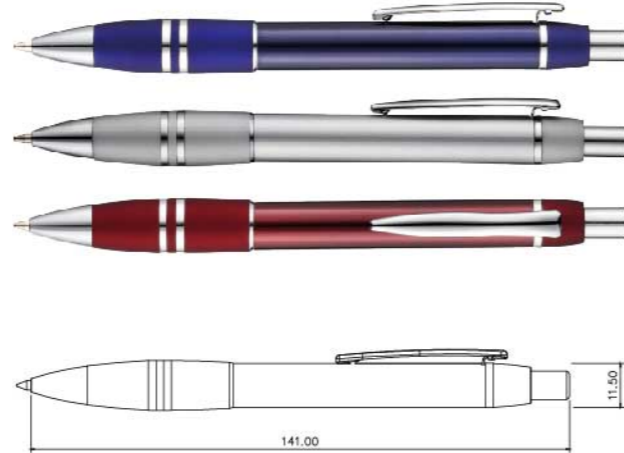

Function: Retractable
 Refill: Parker refill
 Material: Brass
 Packing: 1/50/500
 Meas: 45x30x12cm
 G.W.: 11.5Kg N.W.: 10.5Kg

SKS841-2

Unit Weight(g): 21
 Length(mm): 140.7
 Diameter(mm): 9.5
 Tip point:0.8/1.0mm
 Logo size:60x6.5mm

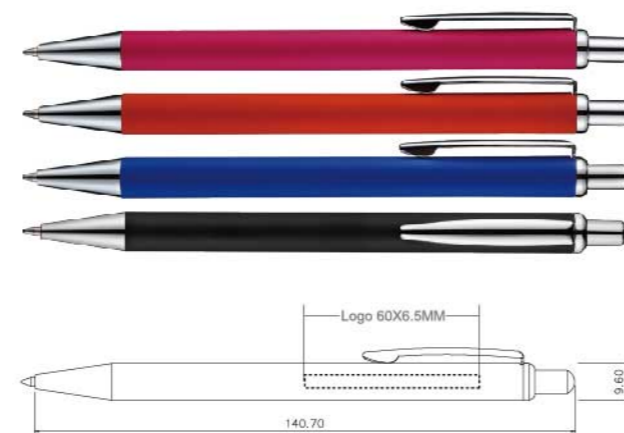

Retractable Parker Series



Function: Retractable
 Refill: Parker refill
 Material: Aluminum
 Packing: 1/50/500
 Meas: 45x30x12cm
 G.W.: 10Kg N.W.: 9Kg

SKS860

Unit Weight(g): 18
 Length(mm): 135.5
 Diameter(mm): 9.8
 Tip point:0.8/1.0mm
 Logo size:45x7mm

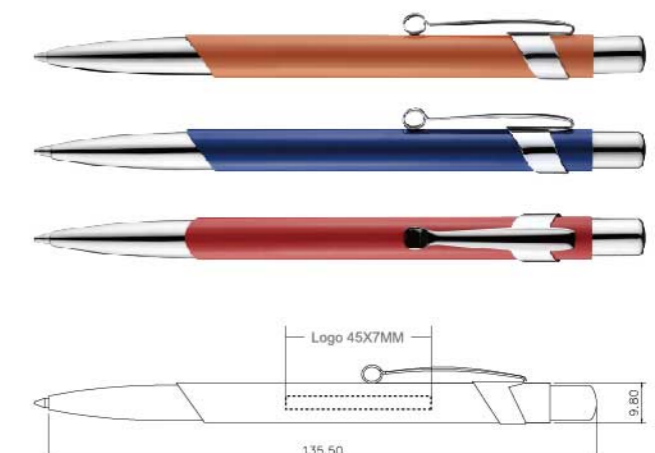

Function: Retractable
 Refill: Parker refill
 Material: Aluminum
 Packing: 1/50/500
 Meas: 45x30x12cm
 G.W.: 10Kg N.W.: 9Kg

SKS868

Unit Weight(g): 18
 Length(mm): 142.1
 Diameter(mm): 10.7
 Tip point:0.8/1.0mm
 Logo size:45x5.5mm

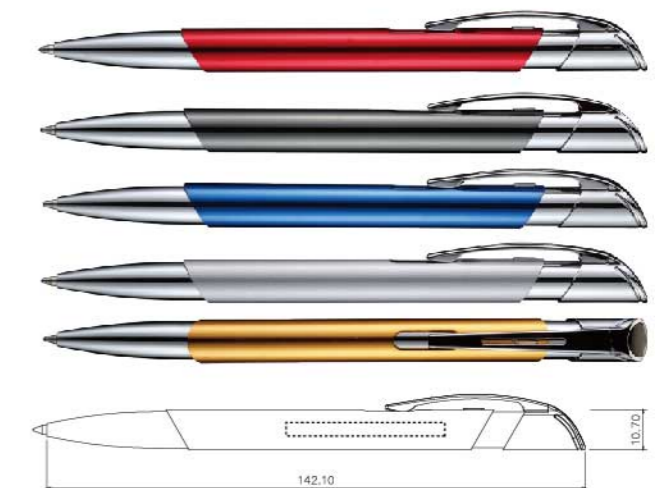

Retractable Parker Series

SKS881-1

Unit Weight(g): 21.5
 Length(mm): 139
 Diameter(mm): 12
 Tip point:0.8/1.0mm
 Logo size:38x8mm



Function: Retractable
 Refill: Parker refill
 Material: Brass
 Packing: 1/50/500
 Meas: 45x30x12cm
 G.W.: 11.5Kg N.W.: 10.5Kg

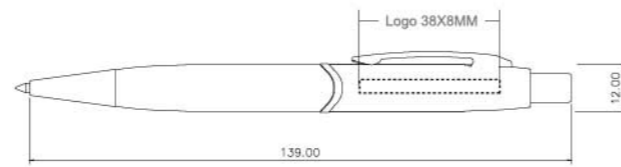

SKS893-1

Unit Weight(g): 20
 Tip point:0.8/1.0mm
 Logo size:45x9mm



Function: Retractable
 Refill: Parker refill
 Material: Aluminum
 Packing: 1/50/500
 Meas: 45x30x12cm
 G.W.: 11Kg N.W.: 10Kg

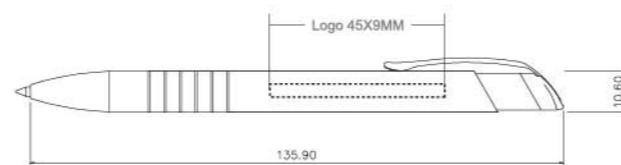

Packing



BLISTER CARD



HOURLASS



COLOR WINDOW BOX

PLASTIC BOX



SKSB051



SKSB052



SKSB053



SKSB054



SKSB055



SKSB056



SKSB057



SKSB058



SKSB059



SKSB060



SKSB061

Packing

LEATHER BOX



SKSB083



SKSB067



SKSB068



SKSB069



SKSB070



SKSB076



SKSB077



SKSB078



SKSB079

Packing

PAPER BOX



SKSB062



SKSB063



SKSB064



SKSB065



SKSB083



SKSB084

Tin BOX



SKSB072



SKSB073



SKSB071
PAPER+PVC BOX

PU BAG



SKSB074



SKSB075

